

LED SURFACE LIGHT

Product&Family Code:

016 067 0020

ANDREA/S-20

Technical Data

Voltage (V)	170-265V
Product Wattage (W)	20
Equivalence with incandescent lamp	160
Colour Render Index (Ra)	>70
Colour Temperature (K)	6400K
Materials	ALUM. DIE CASTING+ PC
Protection Class	II
Dimmable	No
Warm-up time up to 60 %of the full light output	Instant Full Light
Luminous Flux (lm)	1700
Luminous Efficacy (lm/W)	85
Rated Life (hrs) Ⓢ	25.000
IP Rating	54
Power Factor	>0.5
Beam Angle	120°
Starting Time	<0.2s
Number of ON-OFF cycling	x12.500



WHITE



Fast Connector



Release the bracket through push or pull the plastic button

Technical Drawing

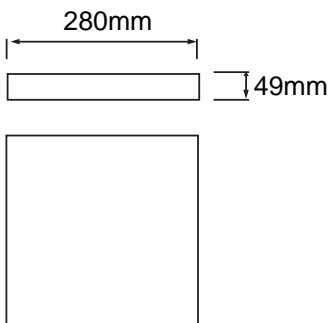

Applications

Airport, Bathroom, Bedroom, Car Park, Cinema, Gallery, Hospital, Hotel, Kitchen, Museum etc.



Features

- High Lumen and CRI, Good quality & Constant Current driver.
- High heat dissipation, low carbon and environmental protection.
- Innovative design of assembly structure.
- Extremely Long Life.

