

LED BULB

Product&Family Code: 001 002 0006

PLUS-6



Technical Drawing

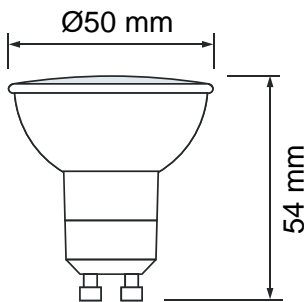

Photometric Diagram

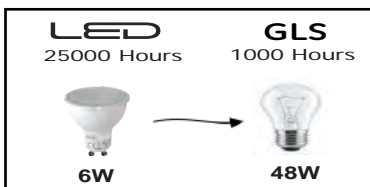
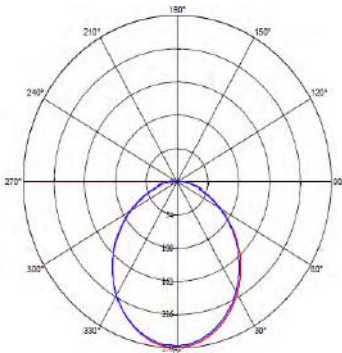

Technical Data	
Voltage (V)	175-250V
Product Wattage (W)	6
Equivalence with incandescent lamp	48
Colour Render Index (Ra)	>Ra80
Colour Temperature (K)	3000K-4200K-6400K
Materials	Aluminium Housing with PMMA Diffuser
Protection Class	-
Dimmable	No
EEL	
Warm-up time up to 60 % of the full light output	Instant Full Light
Luminous Flux (lm)	440
Luminous Efficacy (lm/W)	73
Rated Life (hrs) Ⓟ	25.000
IP Rating	-
Power Factor	>0.5
Beam Angle ☆	105 °
Starting Time	<0.5
Number of ON-OFF cycling	x12.500







Applications

- The luminaire is an excellent solutions for market, museum, restaurant, show room, and other spot lighting needed.



Features

- Low power consumption
- Efficient replacement for incandescent lamps
- Mercury free, no UV and IR radiation
- Instant on, 100% light output

	12.500X ON / OFF	 0,0mg	 Optimally
NO UV / IR	mA 52	Ra >80	Warm Up %60 < 0.5 sc.
	Start Up Time <0.5	 105 °	 -10°C 40°C
%85 ENERGY Saving	 25000h Lifetime	PF >0.5 Power Factor	