

LED SURFACE LIGHT



WHITE

BLACK

Technical Drawing

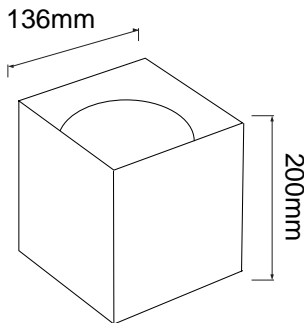

Photometric Diagram

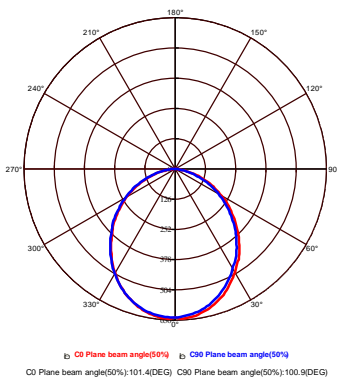

Product&Family Code:

016 045 1010

SANDRA-SQ10/XL

Technical Data

Voltage (V)	185-264V
Product Wattage (W)	10
Equivalence with incandescent lamp	80
Colour Render Index (Ra)	>Ra70
Colour Temperature (K)	4200K
Material	Aluminium
Protection Class	II
Dimmable	No
EEL	-
Warm-up time up to 60 %of the full light output	Instant Full Light
Luminous Flux (lm)	700
Luminous Efficacy (lm/W)	70
Rated Life (hrs) ⌚	30.000
IP Rating	20
Power Factor	>0.5
Beam Angle	100°
Starting Time	<0.2s
Number of ON-OFF cycling	x15.000

Applications

- Airport, Bathroom, Bedroom, Cinema, Gallery, Hospital, Hotel, Kitchen etc.



Features

- High Lumen and CRI, Good quality & Constant Current driver.
- High heat dissipation, low carbon and environmental protection.
- SMD LED Lamp Base.

